

Card Edge Connector

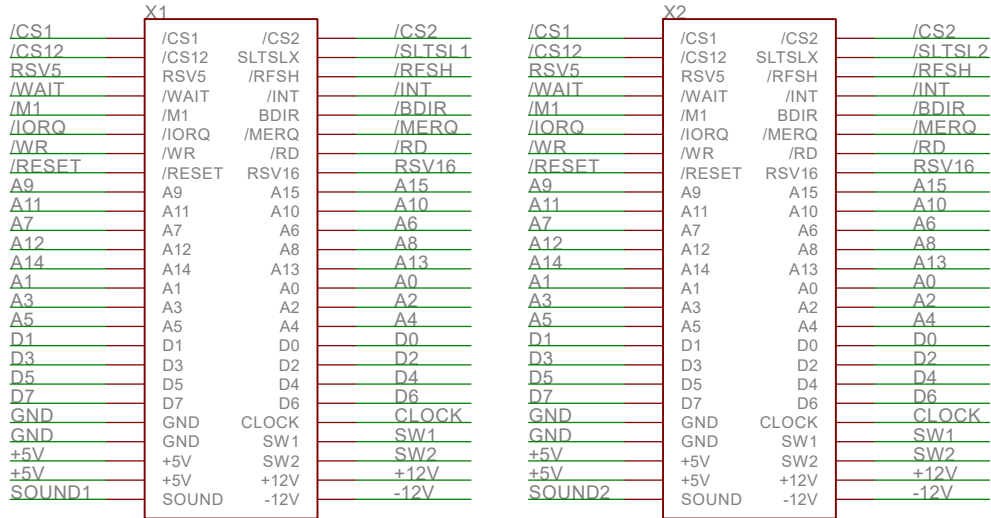

DE0 Connector

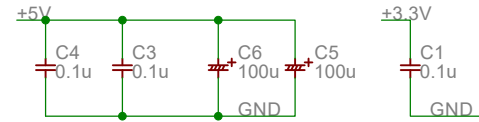
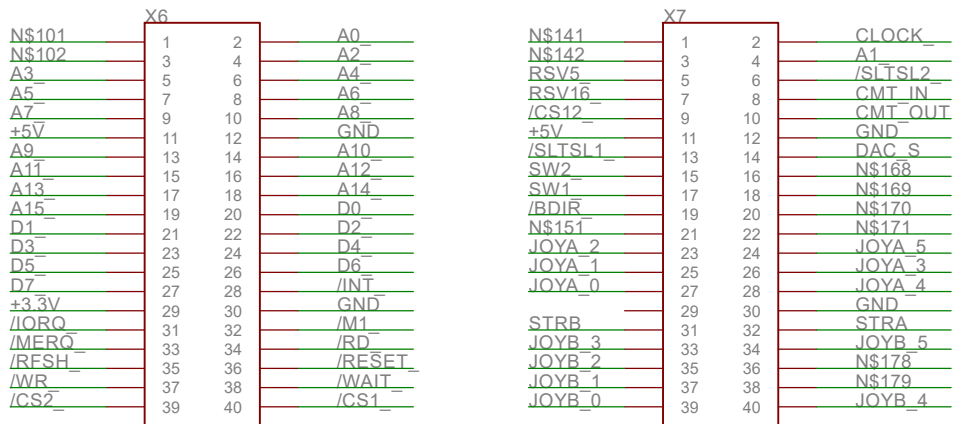

SOUND

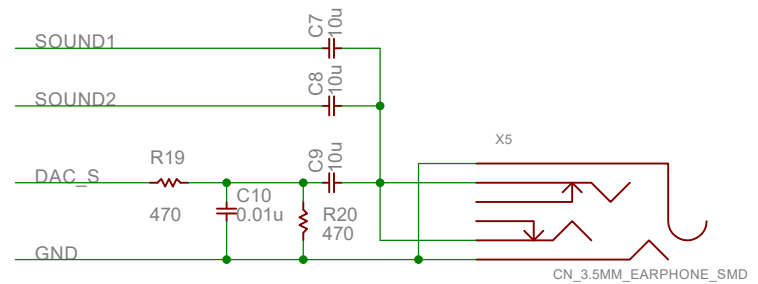

TAPE

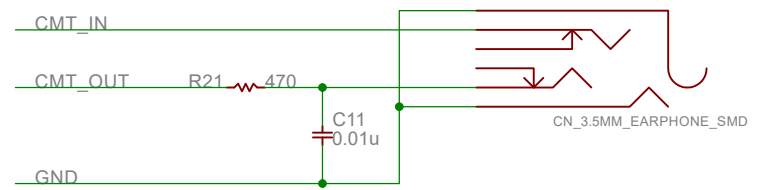

deocm

2018/12/02 21:11:54

Sheet: 1

Damping Resistor

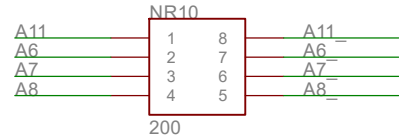
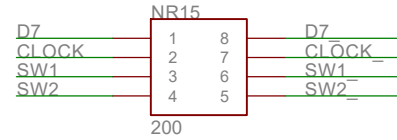
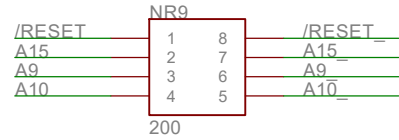
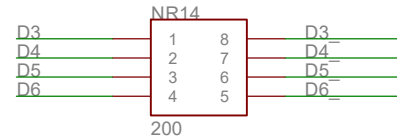
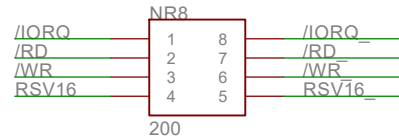
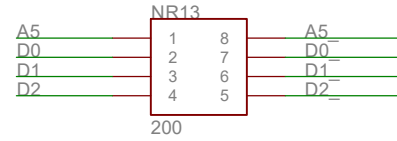
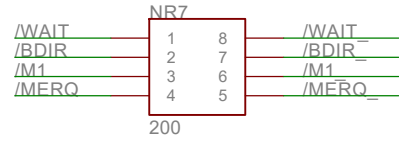
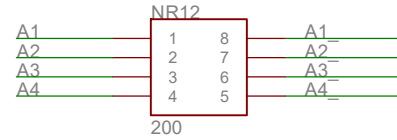
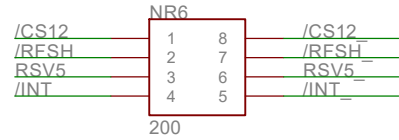
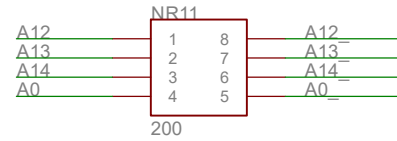
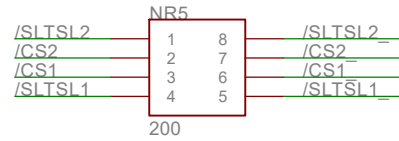

D-SUB

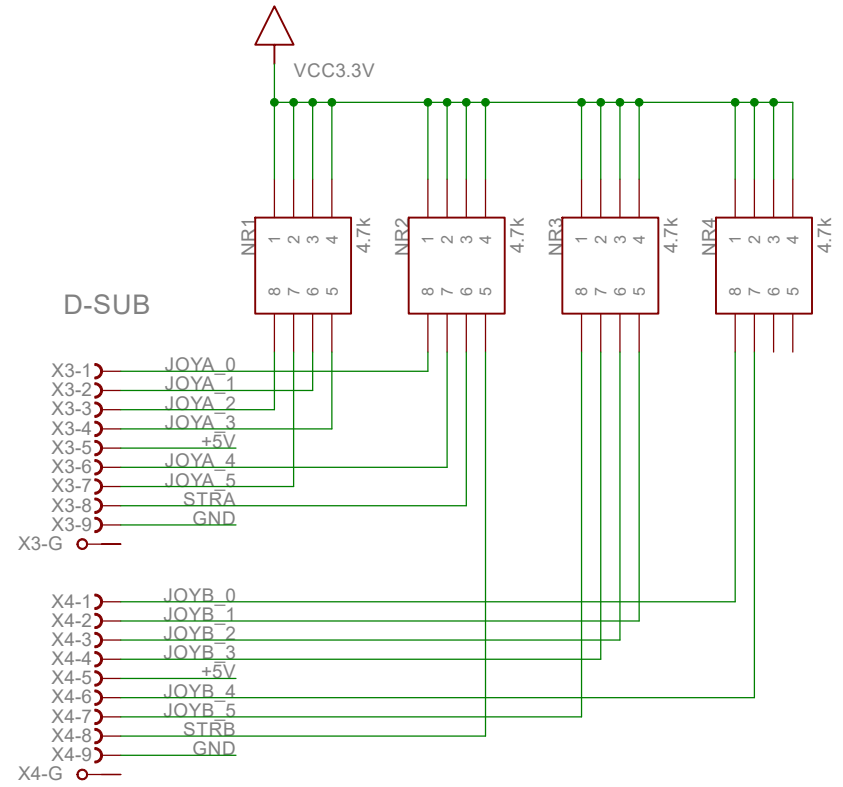

DC/DC (option)

